



*Divan d'examen hauteur fixe*  
*Gamme ECOMAX*  
**ECOMAXDBLEMIX**

**CARINA**  
*Medical*



**CE**  
ISO 9001  
ISO 13485

## DESCRIPTION TECHNIQUE

- Divan d'examen double mixte à hauteur fixe, 3 parties gynéco
- Réglage de la tête par 2 crémaillères indexables
- Sellerie tendue plate de bonne densité 24kg/cm<sup>2</sup>, non-feu classée M2, épaisseur 6cm
- Equipé d'un porte-rouleau pour drap d'examen : possibilité de le fixer côté pied ou côté tête
- Avec une paire d'étaux, une paire d'étriers et un bac inox
- Piètement acier peint époxy, coloris argent

## DIMENSIONS

- Largeur 60cm
- Hauteur 80cm
- Capacité de charge : 150kg

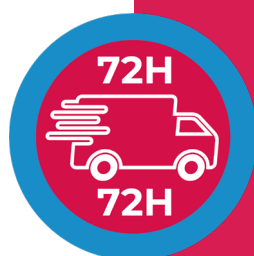
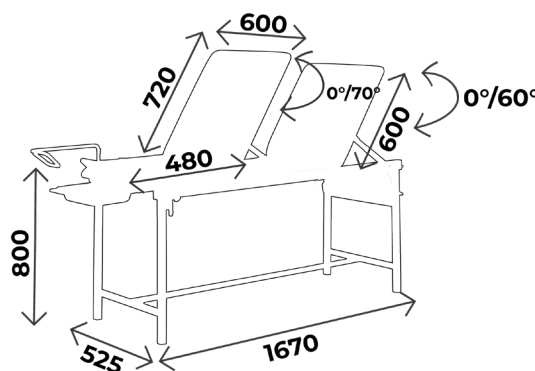

### À SAVOIR

- ✓ Livré démonté (plus value montage)
- ✓ Garantie : 5 ans (1 an pour la sellerie)

## ACCESSOIRES

### ACC 538-110

Jeu d'étaux pour gamme  
ECOMAX pour appuis bras



### ACC 76C

Étai unitaire  
pour tige porte-sérum diam. 16mm



### ACC 32012

Tige porte-sérum diam. 16mm  
2 crochets plastiques, sans étau



### ACC 110

Gouttière prise de sang  
Avec ferrure, sans étau, l'unité



### ACC 110POLY

Gouttière prise de sang  
polyuréthane avec ferrure  
Sans étau, l'unité



### ACC 964

Jeu de repose jambes noir,  
sur rotule mousse polyuréthane,  
diam. 14mm, sans étau



### SLFEMIREPOSE

Housse prélude pour repose  
jambes (ACC964), l'unité



### ACC 514-UNIVERSE

Protection plastique transparent  
universelle



### ACC 832

Trou visage avec bouchon

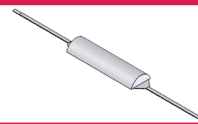

### ACC 54001

Têteière 1/2 lune largeur 60cm  
revêtement non feu M1



### ACC BARRILITECOM

Paire de barrières de lit  
escamotables largeur 60cm

## COLORIS SELLERIE

Sellerie non-feu  
classée M2

Pour les coloris de sellerie, vous avez le choix entre la gamme ECOMAX, Classique et Urban  
Attention ! coloris Classique et Urban **avec plus value**

### *Revêtement : Sellerie Gamme ECOMAX\**



Galapagos



Bahamas



Blanc



Tahiti



Malouines

\*Coloris standards pour gamme ECOMAX et SIMPLEX,  
coloris Classique et Urban disponibles **sur demande**

# COLORIS SELLERIE

Sellerie non-feu  
classée M1

Attention ! coloris Classique et Urban avec plus value

## Revêtement : Sellerie Gamme Classique

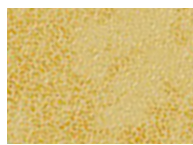

Arno



Garonne



Potomac



Amour

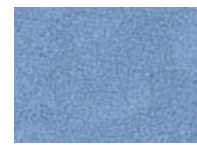

Mississippi

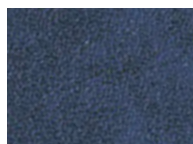

St Laurent



Rhône

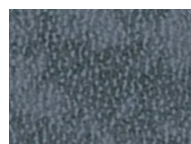

Missouri



Seine

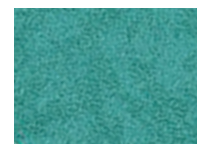

Amazone

## Revêtement : Sellerie Gamme Urban



Abysse



Cendre



Origan



Géranium



Réglisse



Prune

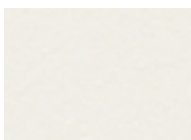

Perle

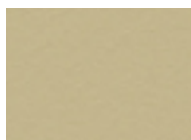

Ficelle

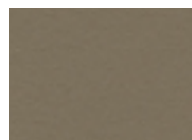

Terre

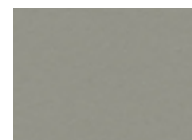

Béton

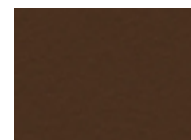

Chataigne

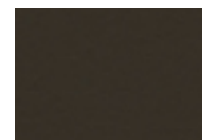

Chocolat

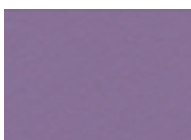

Pensée



Pétrole



Turquoise



Granny



Absinthe



Ananas



Orange



Fuschia



Tomate



## GUIDE D'ENTRETIEN

### ENTRETIEN QUOTIDIEN

- Sellerie : nettoyage à l'eau savonneuse uniquement (solvants proscrits), peut être désinfecté avec des produits tels que Phagosept Spray, Salvanios pH10 à 0,75% et Anios Surfaces Hautes, sans matière abrasive
- Piètement : nettoyage à l'eau savonneuse uniquement (solvants proscrits) sans matière abrasive

### GARANTIE

- Châssis : 5 ans
- Sellerie : 1 an



**CONTACT**

**CARINA**  
*Médical*

Parc d'entreprises Visionis  
278 rue de l'industrie  
01090 GUÉREINS- FRANCE

**SERVICE COMMERCIAL**

Tél : +33(0)4 74 66 69 49  
Fax : +33(0)4 74 66 69 50  
[commercial@carinamedical.com](mailto:commercial@carinamedical.com)